



## INSTALLATION AND OPERATION MANUAL

Software version: 1.5x

code 80396M - 02/2014 - ENGLISH

### INDEX

<b>1 Introduction</b>	<b>2</b>	<b>4 Installation of serial network</b>	<b>23</b>
1.1 General description		4.1 AUTOBAUD sequence Serial 1	
1.2 Preliminary instructions		4.2 AUTOBAUD sequence Serial 2	
<b>2 Installation and Connection</b>	<b>3</b>	<b>5 Technical Data</b>	<b>25</b>
2.1 Electrical power supply			
2.2 Notes on electrical safety and electromagnetic compatibility			
2.3 Instrument power supply			
2.4 Input and output connections			
2.5 Dimensions			
2.6 Installation			
2.7 General description			
2.8 Inserting the field bus interface board			
<b>3 Electrical connections</b>	<b>8</b>	<b>6 Commercial information</b>	<b>27</b>
3.1 Connector J1 outputs 5...10		6.1 Accessories	
3.2 Connector J2 power supply, digital inputs			
3.3 Connector J3 auxiliary inputs			
3.4 Connector J4 inputs IN1...IN4			
3.5 Description of dip-switches			
3.6 Serial communication ports			
3.7 Connection example: communication ports			

### GRAPHIC SYMBOLS

To differentiate the type and importance of the information in this User Manual, graphic reference symbols are used to make such information easier to interpret.



Indicates contents of sections, general instructions, notes, and other points to which the reader's attention needs to be called.



Indicates a suggestion based on the experience of GEFran's Technical Personnel that could be especially useful under certain circumstances.



Indicates a particularly delicate situation that could affect the safety or correct operation of the controller, or an instruction that **MUST** be followed to prevent hazards.



Indicates a reference to Detailed Technical Documents available on the GEFran website [www.gefran.com](http://www.gefran.com).



Indicates a risk to the user's safety due to high voltage at the points indicated.

# 1 • PRELIMINARY INSTRUCTIONS

 *The section contains general information and warnings to be read before installing, configuring and using the controller.*

Check that the order code matches the configuration requested for the intended application by consulting the section: “Technical-Commercial Information.”

## 1.1 GENERAL DESCRIPTION

GFXTERMO4 is an extremely compact, independent unit for separate control of 4 zones, complete with communication interface in all popular fieldbus standards.

It offers an exclusive combination of performance, reliability, and flexibility. In particular, this new line of Gefran controllers is the ideal solution for sectors demanding high performance and continuity of service, such as:

- plastics injection presses
- thermoforming machines
- packaging and packing machines
- etc.

Series GFXTERMO4 controllers are based on an extremely versatile hardware and software platform, with options to select the best I/O configuration for your system.

 *Attention: the description of programming and configuration parameters are contained in the “Programming and configuration” manual, downloadable from the website [www.gefran.com](http://www.gefran.com)*

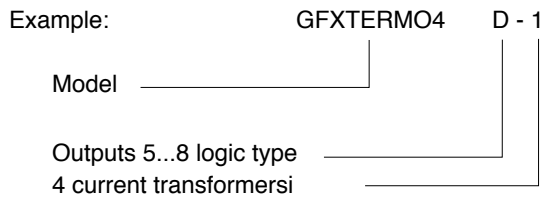

See paragraph 2.1 “Dimensions and mounting” before installing the controller on the machine/host system control panel”.

In case of PC configuration, make sure you have the WINSTRUM Kit.

For the order code, see Section 7 “Technical-Commercial Information”.



Users and/or system integrators who want detailed information on serial communication between Gefran standard and/or industrial PCs and Gefran Programmable Instruments can access Technical Reference Documents on serial communication and MODBus protocol, etc., in Adobe Acrobat format on the Gefran website [www.gefran.com](http://www.gefran.com):

- Serial Communication
- MODBus Protocol

## 1.2 PRELIMINARY INSTRUCTION

 *Read the following preliminary instructions before installing and using the GFXTERMO4 modular power controller. This will make start-up faster and avoid some problems that could be mistakenly interpreted as malfunctions or limitations of the controller.*

Before calling Gefran Customer Care in case of assumed malfunctions, please see the Troubleshooting Guide in the “Maintenance” section and, if necessary, the F.A.Q. (Frequently Asked Questions) section on the Gefran website [www.gefran.com](http://www.gefran.com)

Immediately after unpacking the unit, check the order code and the other data on the label attached to the outside of the container.

Write them on the following table.

This data must always be available and given to Gefran Customer Care representatives if technical service is needed.

SN.....	(Serial Number)
CODE .....	(Product code)
TYPE.....	(Order code)
SUPPLY.....	(Type of electrical power supply)
VERS. ....	(Firmware Version)

Check that the controller is in perfect condition, was not damaged during shipment, and that the package also contains the “Configuration and Programming” manual.

Immediately report any errors, shortages, or signs of damage to your Gefran dealer.



This section contains the instructions needed for correct installation of GFXTERMO4 controllers on the machine/host system control panel and for correct connection of the power supply, inputs, outputs and interfaces.



**CAREFULLY READ THE FOLLOWING WARNINGS BEFORE INSTALLING THE INSTRUMENT!**  
**Disregard of such warnings could create electrical safety and electromagnetic compatibility problems, as well as void the warranty.**

### 2.1 ELECTRICAL POWER SUPPLY

- the controller DOES NOT have an On/Off switch: the user must install a 2-phase switch/isolator conforming to safety requisites (CE mark) to cut off the power supply up-line of the controller.  
 The switch must be installed in the immediate vicinity of the controller in easy reach of the operator.  
 A single switch can be used for multiple controllers.
- if the controller is connected to devices that are NOT electrically isolated (for example, thermocouples), the ground connection must be made with a specific conductor and NOT via the machine structure.
- if the controller is used in applications with risk of harm to persons or damage to machines or materials, it MUST be equipped with auxiliary alarm devices.  
 It is advisable to provide the ability to check for tripped alarms during regular operation.  
 DO NOT install the controller in rooms with hazardous (inflammable or explosive) atmosphere; it may be connected to elements that operated in such atmosphere only by means of appropriate interfaces that conform to current safety standards.

### 2.2 NOTES ON ELECTRICAL SAFETY AND ELECTROMAGNETIC COMPATIBILITY:

#### 2.2.1 CE MARK: EMC

**(electromagnetic compatibility) conformity**

in compliance with Directive 89/336/CEE and following modification.

Series GFXTERMO4 controllers are mainly intended for industrial use, installed on panels or control panels of production process machines or systems.

For purposes of electromagnetic compatibility, the most restrictive generic standards have been adopted, as shown on the table

#### 2.2.2 LV (low voltage) conformity

in compliance with Directive 2006/95/CE

EMC conformity has been verified with the connections indicated on table 1.



Recommendations for Correct Installation for purposes of EMC

### 2.3 INSTRUMENT POWER SUPPLY

- The power supply for the electronic instrumentation on the panels must always come directly from a cut-off device with fuse for the instrument part.
- Electronic instrumentation and electromechanical power devices such as relays, contactors, solenoids, etc., MUST ALWAYS be powered by separate lines.
- When the power supply line of electronic instruments is heavily disturbed by switching of thyristor power groups or by motors, you should use an isolation transformer only for the controllers, grounding its sheathing.
- It is important for the system to be well-grounded:
  - voltage between neutral and ground must not be > 1V
  - Ohmic resistance must be < 6Ω;
- If the grid voltage is highly unstable, use a voltage stabilizer.
- In proximity of high-frequency generators or arc welders, use adequate grid filters.
- The power supply lines must be separate from instrument input and output lines.
- Supply from Class II or from limited energy source

### 2.4 INPUT AND OUTPUT CONNECTIONS

- Connected outside circuits must be doubly isolated.
- To connect analog inputs, strain gauges, linears, (TC, RTD), you have to:
  - physically separate the input cables from those of the power supply, outputs, and power connections.
  - use braided and shielded cables, with sheathing grounded at a single point.
- To connect the control outputs and alarm outputs (contactors, solenoids, motors, fans, etc.), install RC (series of capacitors and resistors) groups parallel to inductive loads that work in AC.  
*(Note: all condensers must conform to VDE standards (class X2) and support voltage of at least 220Vac. Resistances must be at least 2W).*
- Install a 1N4007 diode parallel to the coil of inductive loads that work in DC.



**GEFRAN S.p.A. assumes no liability for any damage to persons or property deriving from tampering, from incorrect or improper use, or from any use not conforming to the characteristics of the controller and to the instructions in this User Manual.**

Table 1 EMC Emission

Generic standards, emission standard for industrial environments	EN 61000-6-4	
Emission enclosure	CEI EN 61000-6-4 CISPR-16-1-4 CISPR-16-2-3 CEI R210-010	Class A

Table 2 EMC Immunity

Generic standards, immunity standard for industrial environments	EN 61000-6-2	
ESD immunity	EN 61000-4-2	4 kV contact discharge 8 kV air discharge
RF interference immunity	EN 61000-4-3 /A1	10 V/m amplitude modulated 80 MHz-1 GHz 10 V/m amplitude modulated 1.4 GHz-2 GHz
Conducted disturbance immunity	EN 61000-4-6	10 V/m amplitude modulated 0.15 MHz- 80 MHz
Burst immunity	EN 61000-4-4	2 kV power line 2 kV I/O signal line
Pulse immunity	EN 61000-4-5	Power line-line 1 kV (level 2) Power line-earth 2 kV (level 3) Signal line-earth 1 kV (level 2)
Magnetic fields immunity	EN 61000-4-8	100 A/m (level 5)
Voltage dips, short interruptions and voltage immunity tests	EN 61000-4-11	100%U, 70%U, 40%U,

Table 3 LVD safety

Safety requirements for electrical equipment for measurement, control and laboratory use	EN 61010-1	
--	------------	--

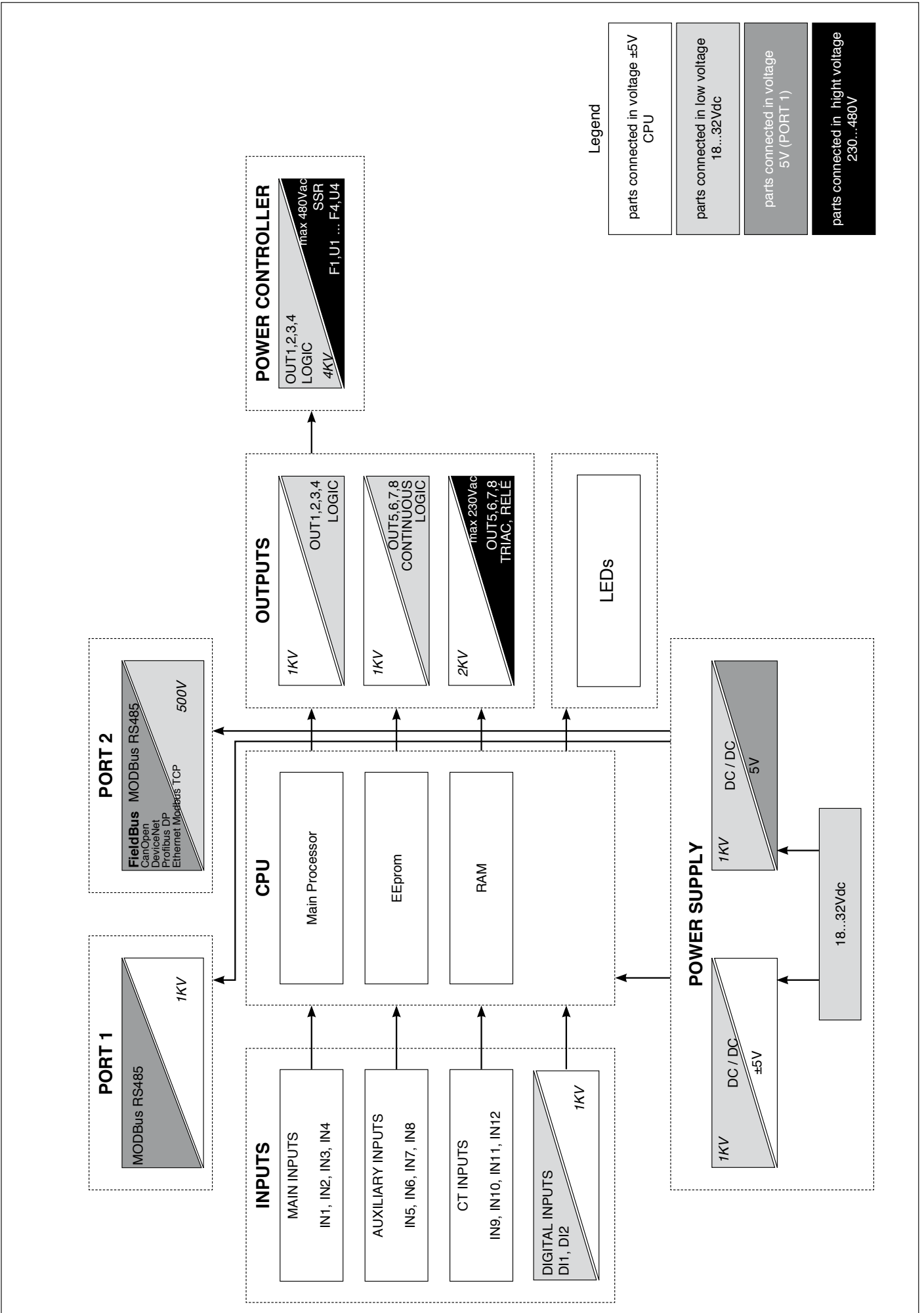

## 2.5 DIMENSIONS

Fastening may be done on DIN guide (EN50022) or with (5MA).  
All dimensions are expressed in mm.

Figure 1

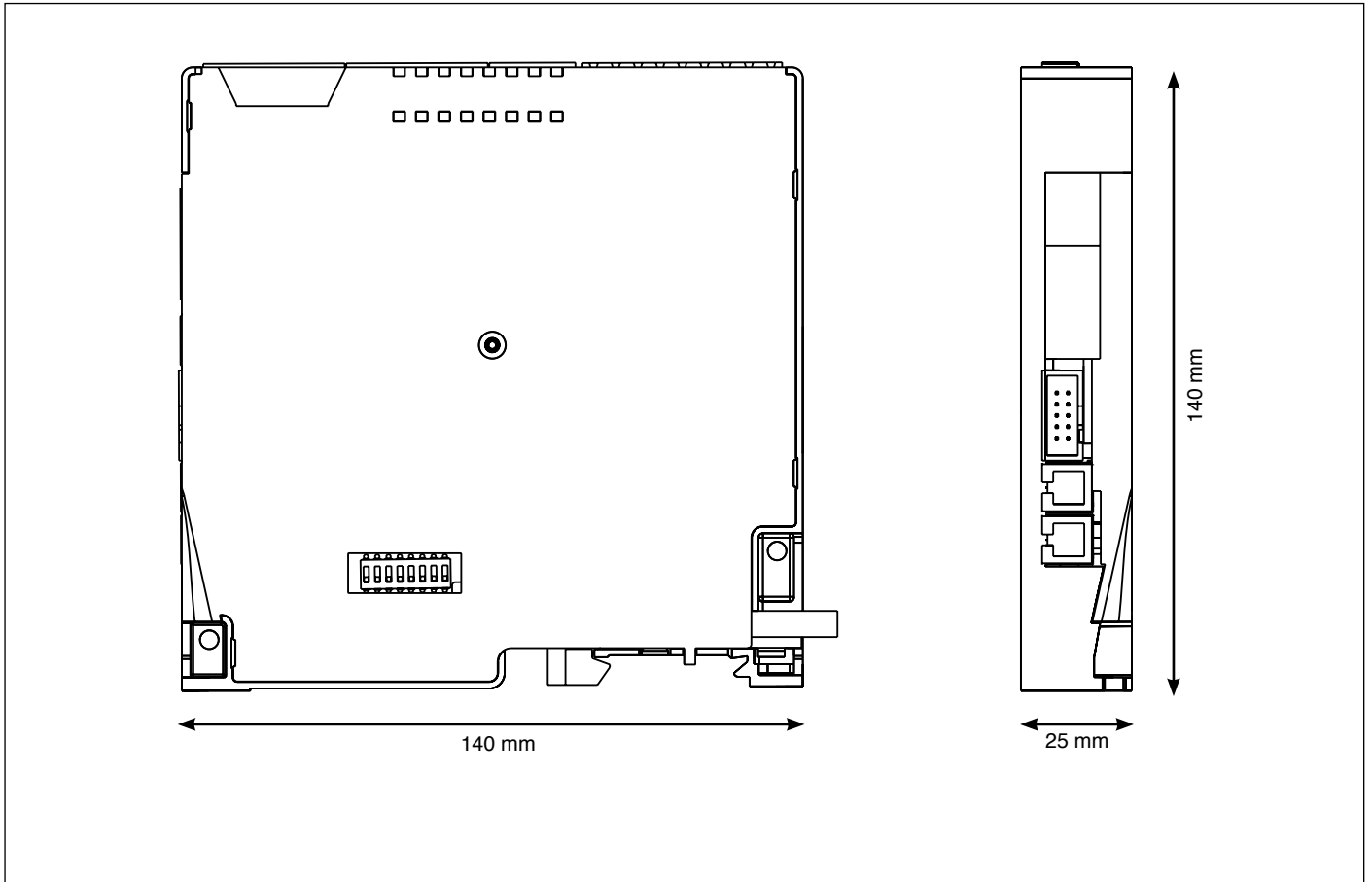

## 2.6 INSTALLATION

For correct attachment/release of the module on the DIN guide, do as follows:

- keep the attach/release cursor pressed
- insert/remove the module
- release the cursor

Figure 2

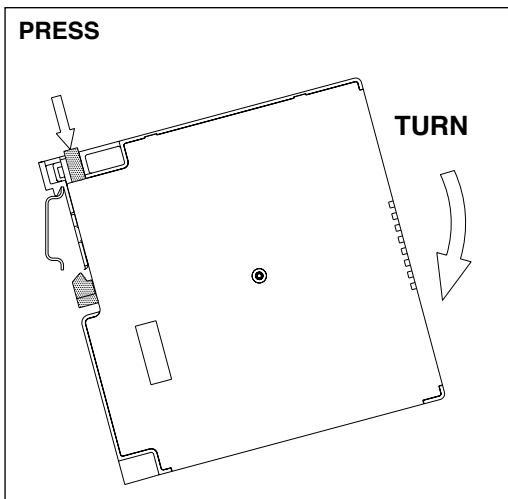

Figure 3

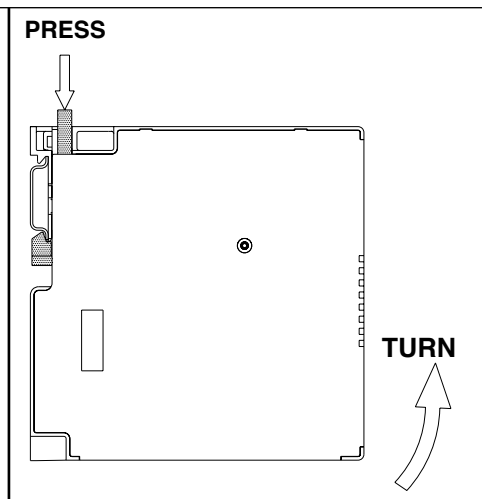

Figure 4

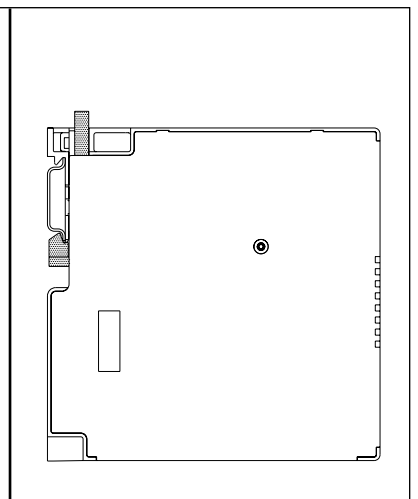
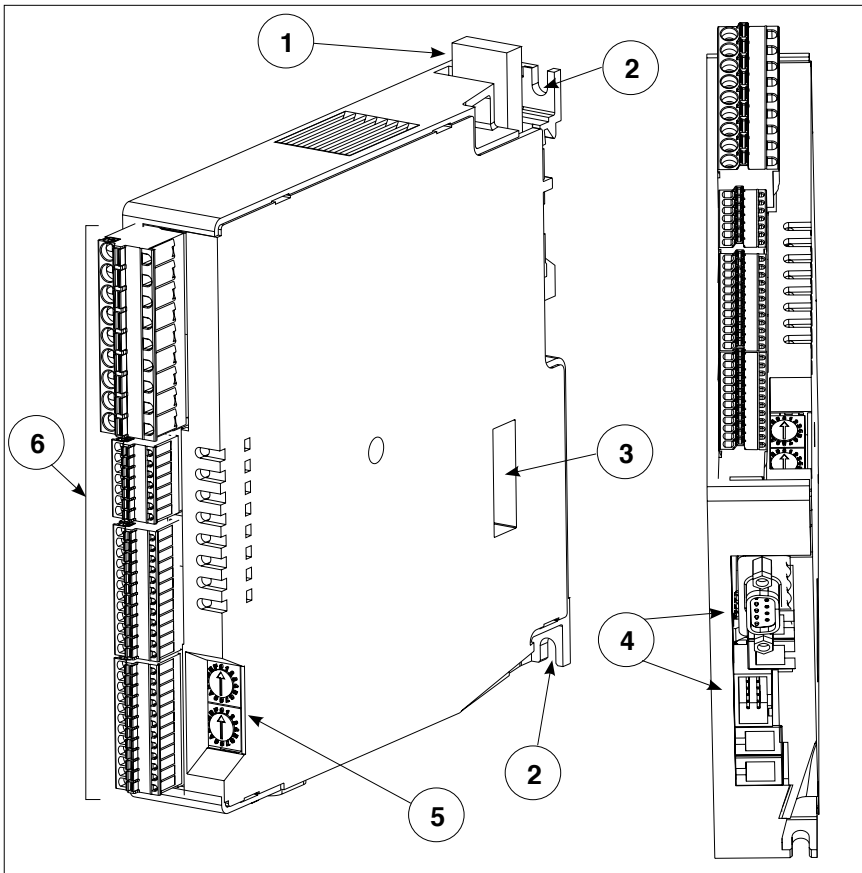

Figure 5



1. cursor for insertion/removal of DIN bar attachment
2. access for screwdriver to power connector screws
3. dip switches for function configuration
4. connectors for communication ports (Port1, Port2)
5. rotary switches for setting node address or number
6. signal and power supply connectors (J1, J2, J3, J4)

2.8 INSERTING THE FIELD BUS INTERFACE BOARD

Figure 6

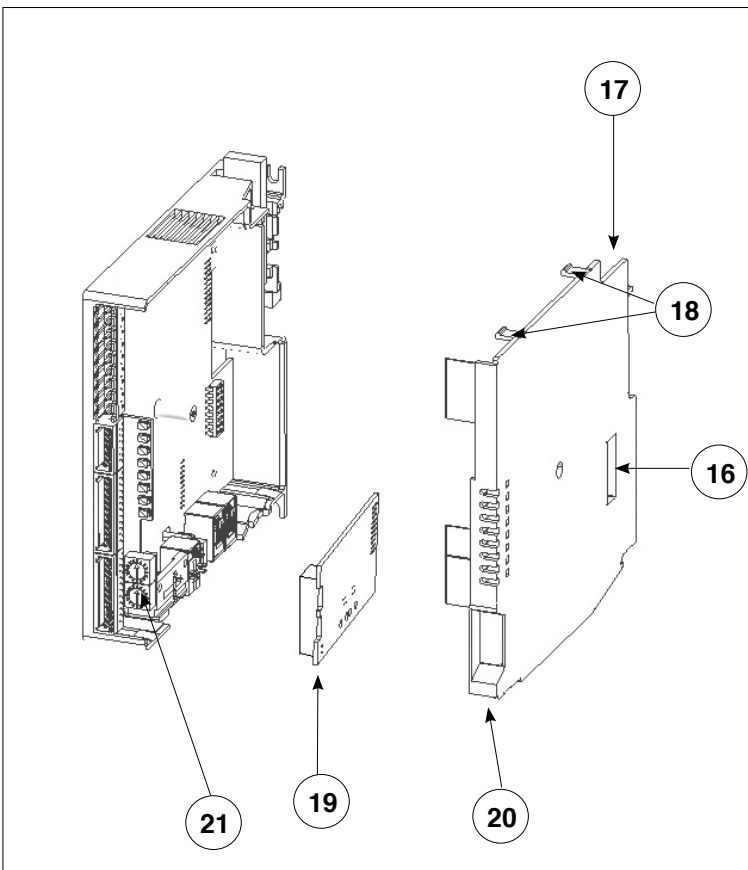

**Do as follows:**

- a. Unscrew screw 16
- b. With a screwdriver, gently apply leverage at points 18
- c. Remove cover 17
- d. Place interface board 19 on the connectors on board 21
- e. Remove pre-broken parts 20 on cover 17 based on the type of interface installed
- f. Reposition cover 17 in its housing
- g. Tighten screw 16

# 3 • ELECTRICAL CONNECTIONS

Use adequate compensated cable for thermocouple inputs. Respect polarity by avoiding junctions on the cables. If the thermocouple is grounded, the connection must be at a single point.  
 For resistance thermometer inputs, use copper extension cables. Resistance must not exceed 20 ohm; avoid junctions on the cables.  
 For 2-wire resistance thermometer, make the connection indicated instead of the third wire.

Figure 7

## logic / communication

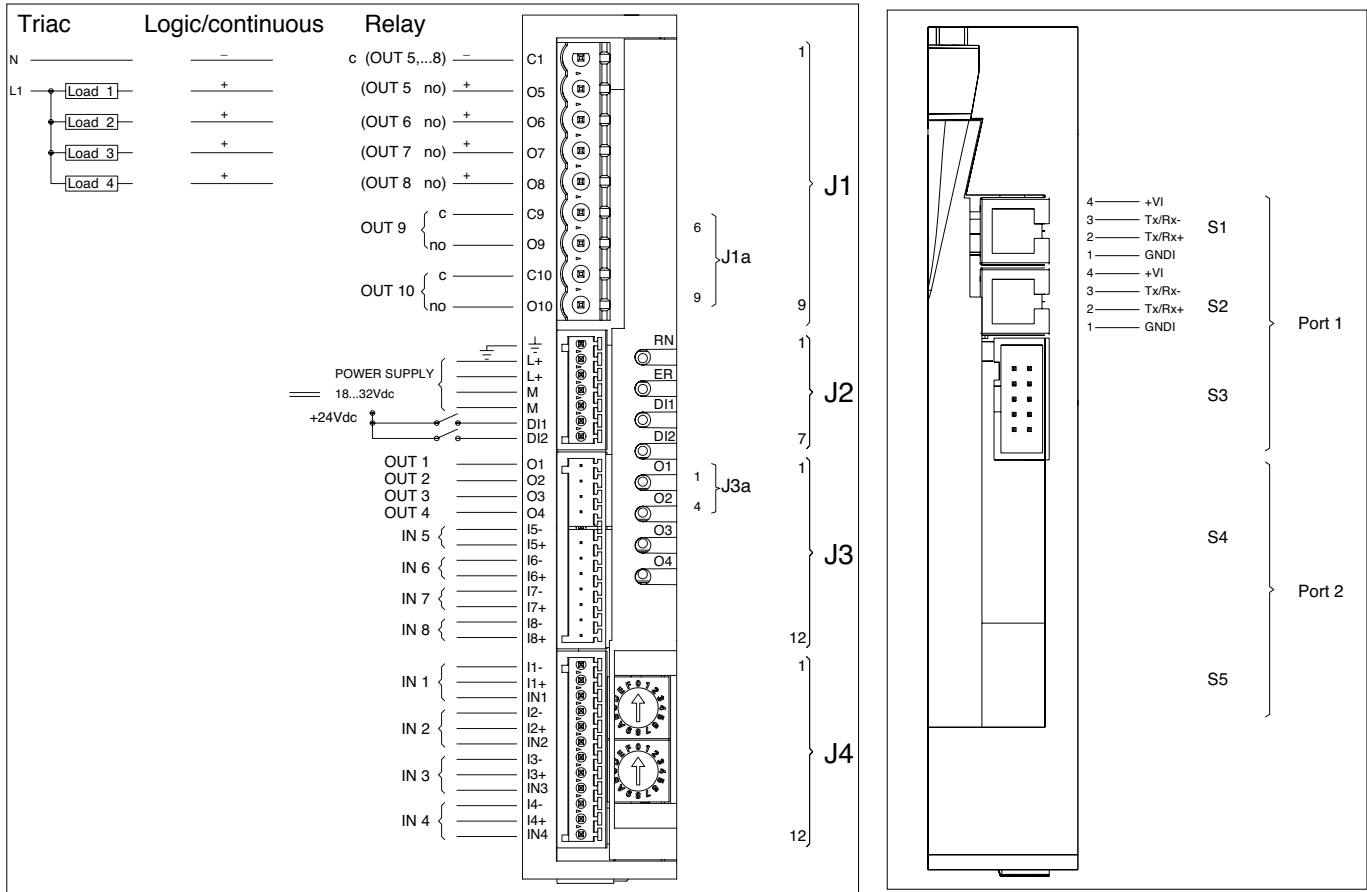
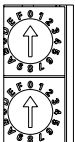



Table 4 Description of LEDs

Led	Description	color
<b>RN</b>	Run - flashing during regular operation	green
<b>ER</b>	Fault state: lights up when fault is present	red
	Lo = process variable value < di Lo.S	
	HI = process variable value > di Hi.S	
	Sbr = probe interrupted or input values over maximum limits	
	Err = third wire interrupted for Pt100 or input values below minimum limits (ex. CT with wrong connection)	
<b>DI1</b>	State of digital input 1	yellow
<b>DI2</b>	State of digital input 2	yellow
<b>O1</b>	State of output Out 1	yellow
<b>O2</b>	State of output Out 2	yellow
<b>O3</b>	State of output Out 3	yellow
<b>O4</b>	State of output Out 4	yellow

Table 5 Description of Rotary Switches

Switch	Description
 <b>x10</b>	Defines address of module 00...99
 <b>x1</b>	(in case of function mode equivalent to four Geflex units, this address is assigned to the first of the four) Hexadecimal combinations are reserved.



### 3.1 CONNECTOR J1 OUTPUTS 5...10

If auxiliary outputs (O5...O8), are present, connector J1a becomes J1.

Figure 8 Connector J1

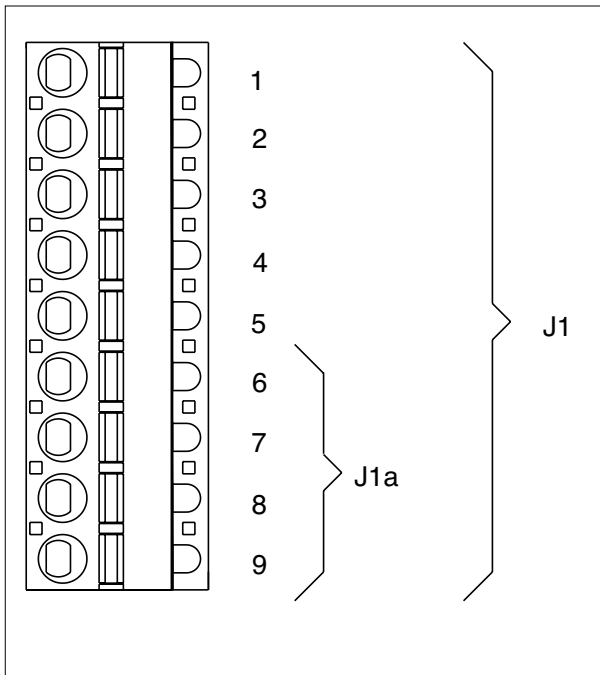

Table 6

	0,2 - 2,5mm <sup>2</sup>	24-14AWG
	0,25 - 2,5mm <sup>2</sup>	23-14AWG

#### Outputs 5...8 logic/continuous type

Logic outputs 18...36Vdc, max 20mA  
 Continuous outputs: voltage (default) 0/2...10V, max 25mA  
 current 0/4...20mA, max 500Ω

Figure 9 Connection scheme for logic/continuous outputs

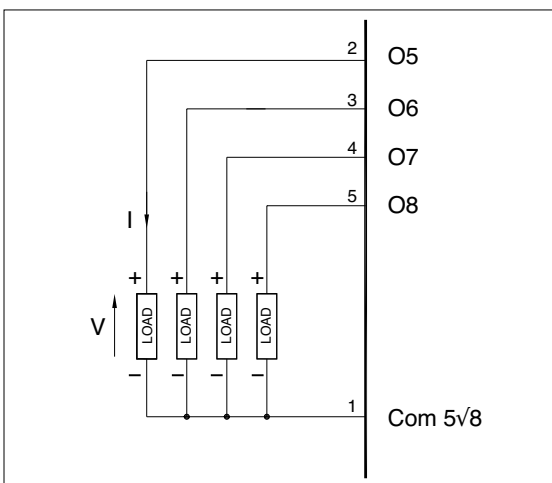
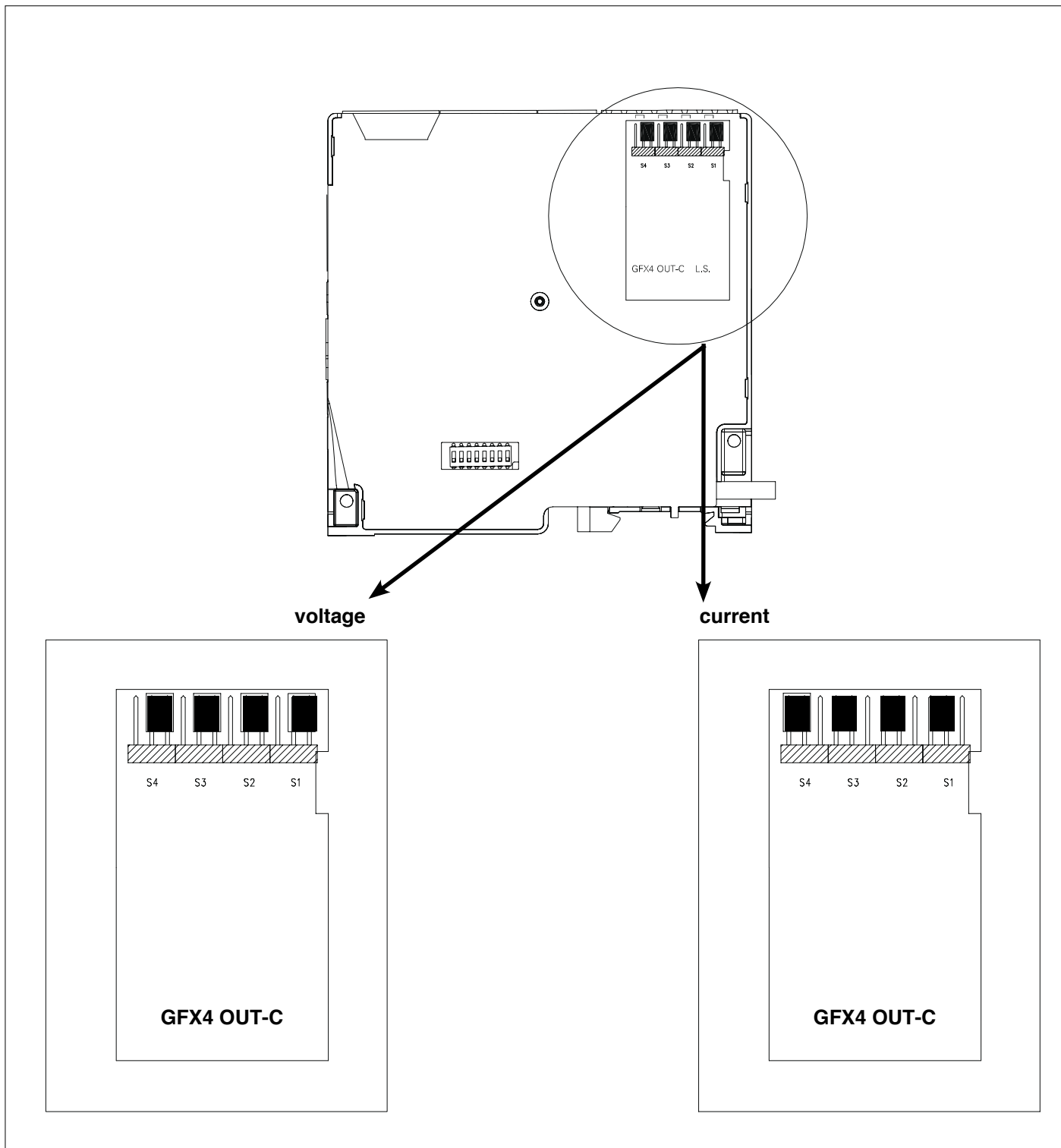

Table 7

PIN	Name	Description	
		Logic	Continuous
1	Com 5-8	Common outputs	(-)
2	O5	Output 5	(+)
3	O6	Output 6	(+)
4	O7	Output 7	(+)
5	O8	Output 8	(+)

Where use of the type "C" output continues, voltage or current setting is carried out using jumpers present on the board as in the following figure 9a

Figure 9a Connection for logic/continuous utputs



**Outputs 5...8 triac type**

Triac outputs Vac = 24...230Vac, max 1A

Figure 10 Connection scheme for triac outputs

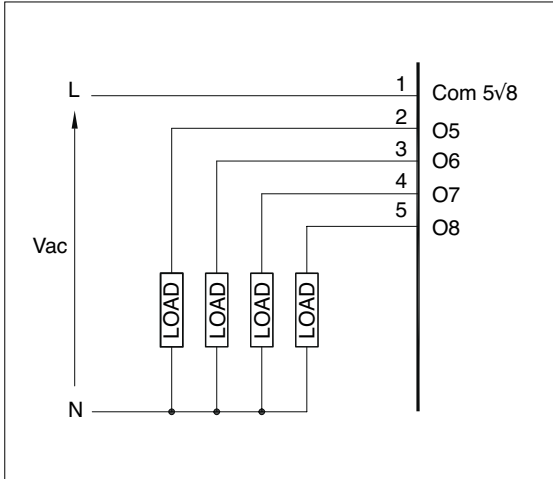

Table 8

PIN	Name	Description
1	Com 5-8	Common outputs
2	O5	Output 5
3	O6	Output 6
4	O7	Output 7
5	O8	Output 8

**Outputs 5...8 relay type**

Outputs Out 5...8 relay Ir = 3A max, NO

V = 250V/30Vdc cosφ = 1; I = 12A max

Figure 11 Connection scheme for relay outputs

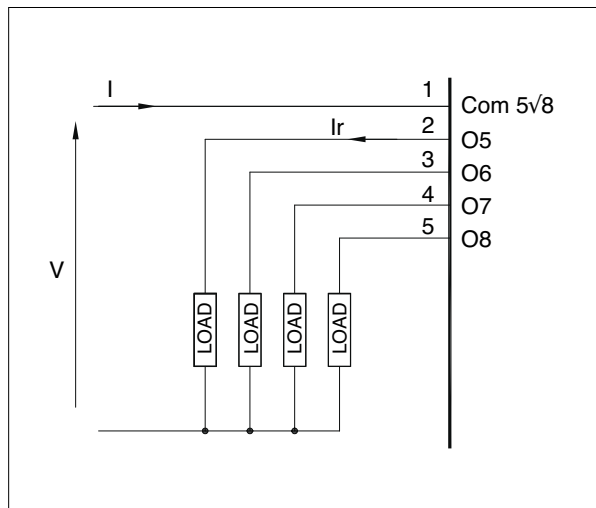

Table 9

PIN	Name	Description
1	Com 5-8	Common outputs
2	O5	Output 5
3	O6	Output 6
4	O7	Output 7
5	O8	Output 8

**Outputs 9, 10 relay type**

Outputs Out 9, 10 relay 5A max, NO

V = 250V/30Vdc cosφ = 1; I = 5A max

Figure 12 Connection scheme for relay outputs

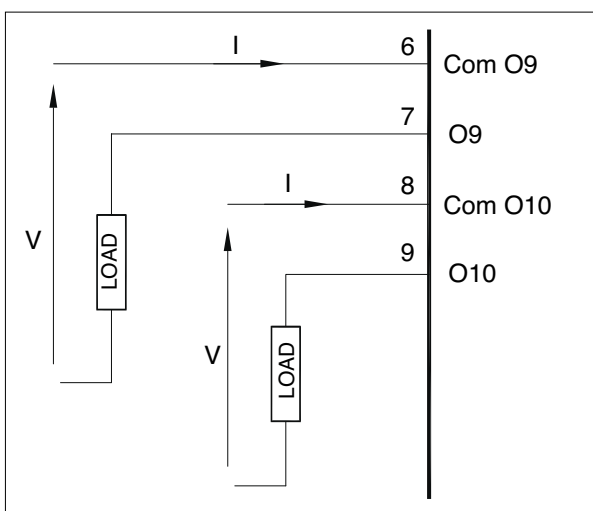

Table 10

PIN	Name	Description
1	Com O9	Common output O9
2	O9	Output O9
3	Com O10	Common output O10
4	O10	Output O10

Figure 13

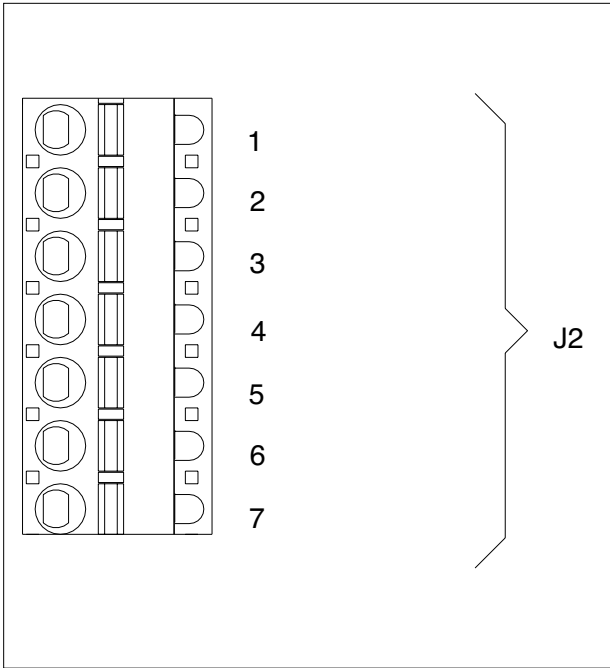

Table 11



	0,14 - 0,5mm <sup>2</sup>	28-20AWG
		
	0,25 - 0,5mm <sup>2</sup>	23-20AWG

Figure 14 Connection scheme for digital inputs and power supply

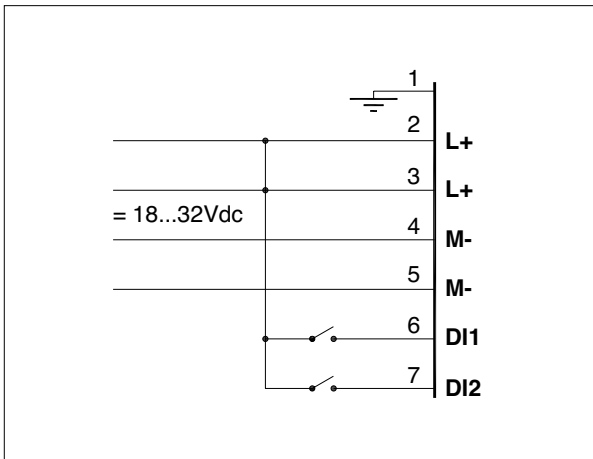

Table 12

PIN	Name	Description
1		ground
2	L+	Power supply 18...32Vdc
3	L+	
4	M-	
5	M-	
6	DI1	
7	DI2	Digital input 2

Figure 15

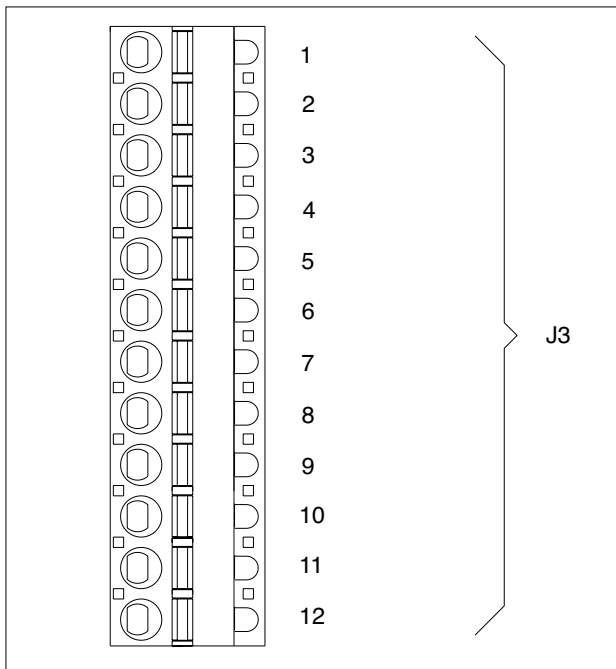

Table 13



	0,14 - 0,5mm <sup>2</sup>	28-20AWG
		
	0,25 - 0,5mm <sup>2</sup>	23-20AWG

Figure 16 Connection scheme for logic outputs 1...4

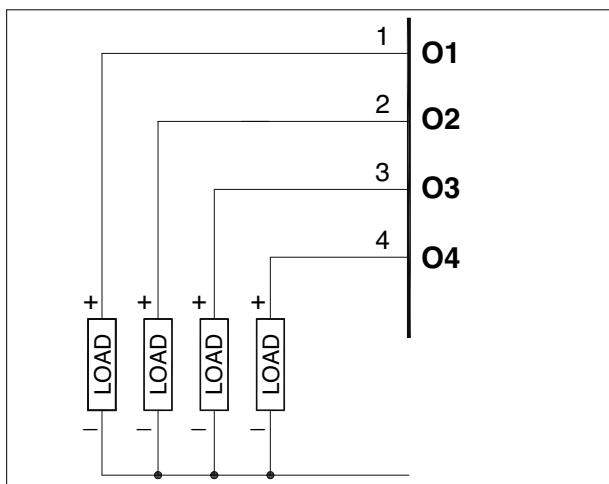

Table 14

PIN	Name	Description
1	O1	Output Out1
2	O2	Output Out2
3	O3	Output Out3
4	O4	Output Out4
5	I5-	Auxiliary input (I5)
6	I5+	or CT Input (I9)
7	I6-	Auxiliary input (I6)
8	I6+	or CT Input (I10)
9	I7-	Auxiliary input (I7)
10	I7+	or CT Input (I11)
11	I8-	Auxiliary input (I8)
12	I8+	or CT Input (I12)

The auxiliary linear inputs are alternative to Current Transformer inputs (see order code)

Figure 16a Connection scheme for 60mV/TC auxiliary linear inputs

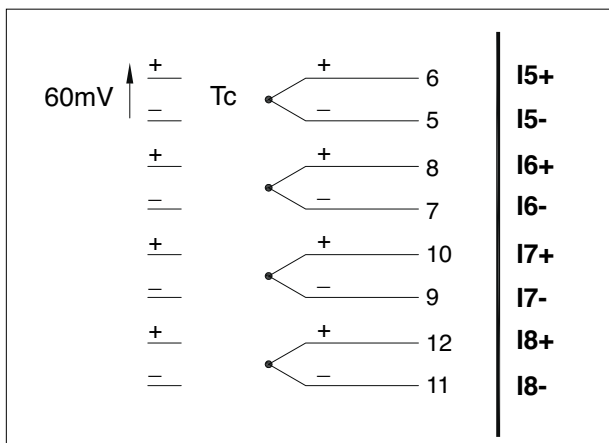

Figure 16b Connection scheme for CT inputs

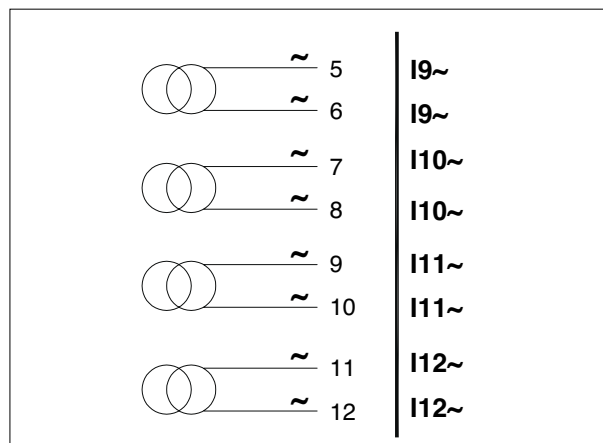

Figure 17

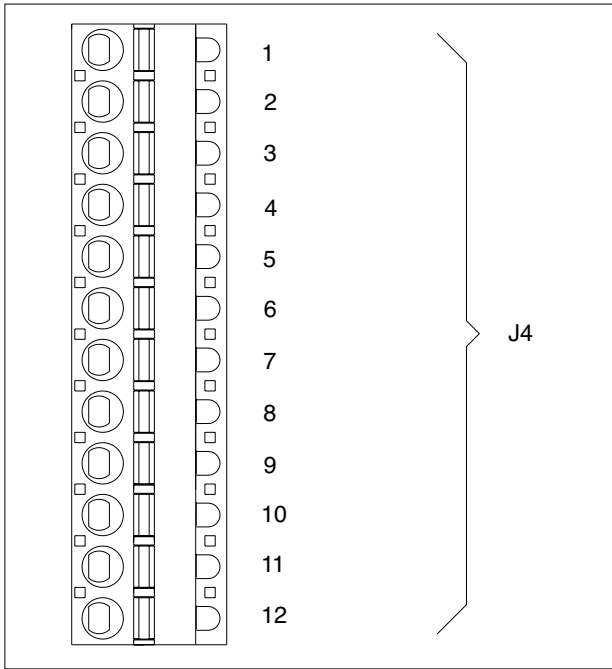

Table 15



	0,2 - 2,5mm <sup>2</sup>	24-14AWG
		
	0,25 - 2,5mm <sup>2</sup>	23-14AWG

Figure 18 Connection scheme for 60mV TC/linear input

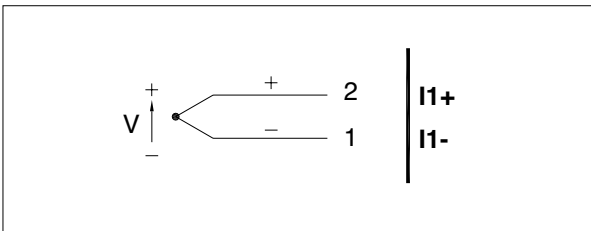

Figure 19 Connection scheme for Pt100 input

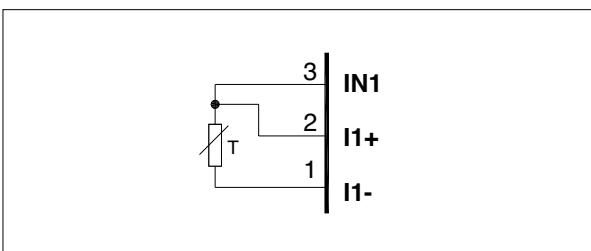

Figure 20 Connection scheme for 1V/20mA linear input

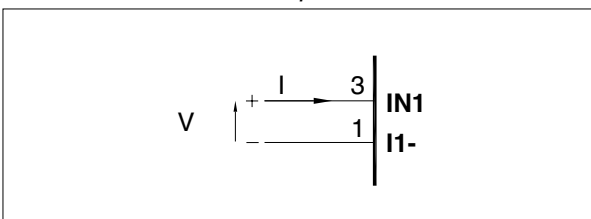

Table 16

PIN	60mV/Tc linear input	1V/20mA linear input	Pt100 input
1	I1-	I1-	I1-
2	I1+		I1+
3		IN1+	IN1
4	I2-	I2-	I2-
5	I2+		I2+
6		IN2+	IN2
7	I3-	I3-	I3-
8	I3+		I3+
9		IN3+	IN3
10	I4-	I4-	I4-
11	I4+		I4+
12		IN4+	IN4

### 3.5 Description of dip-switches

Figure 21

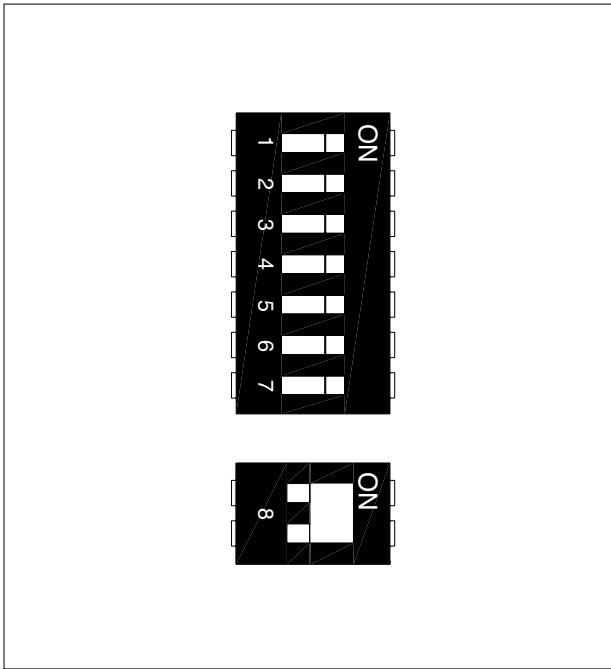

Table 17

dip-switches	Description
1	Connection type: (see table 19-a)
2	Connection type: (see table 19-a)
3	Connection type: (see table 19-a)
4	
5	
6	= ON reset factory configuration
7	= ON Geflex simulation function
8	= ON insert line termination for Port1 / RS485

Table 17-a

1	2	3	Connection type
OFF	OFF	OFF	4 independent zones / 4 loads single-phase
ON	OFF	OFF	zone 1 with 3-phase load star with neutral
OFF	ON	OFF	zone 1 with 3-phase load open triangle
ON	ON	OFF	zone 1, 3 with double 3-phase load star without neutral
OFF	OFF	ON	zone 1, 3 with double 3-phase load closed triangle
ON	OFF	ON	-
OFF	ON	ON	-
ON	ON	ON	-

Port1 (local bus): Modbus serial interface – connectors S1, S2, S3

Figure 22

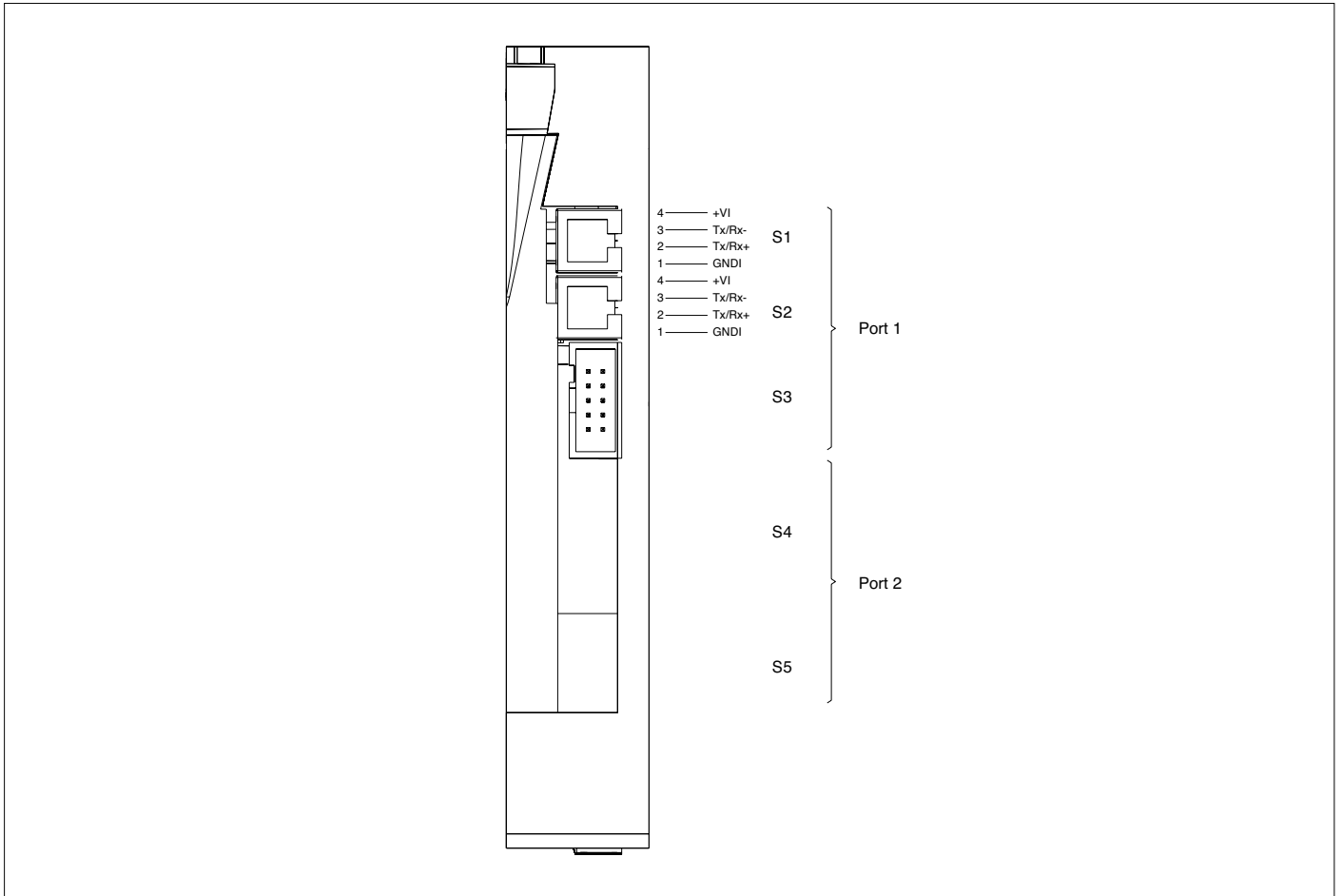

Connector S3 to connection at GFX-OP terminal or to Geflex slave modules (GFX-S1, GFX-S2)

Table 18

Connector S1/S2 RJ10 4-4	Nr. Pin	Nome	Descrizione	Note
	1	GND1 (**)	-	(*) Insert the RS485 line termination in the last device on the Modbus line, see dip-switches.  (**) Connect the GND signal among Modbus devices with a line distance > 100 m.
	2	Tx/Rx+	Data reception/transmission(A+)	
	3	Tx/Rx-	Data reception/transmission (B-)	
	4	+V (reserved)	-	
<b>Cable type:</b> flat telephone cable for pin 4-4 conductor 28AWG				



**Port2 (fieldbus): connectors S4, S5 MODBUS RTU/MODBUS RTU**

Figure 23 Port2: Fieldbus Modbus RTU/Modbus RTU interface

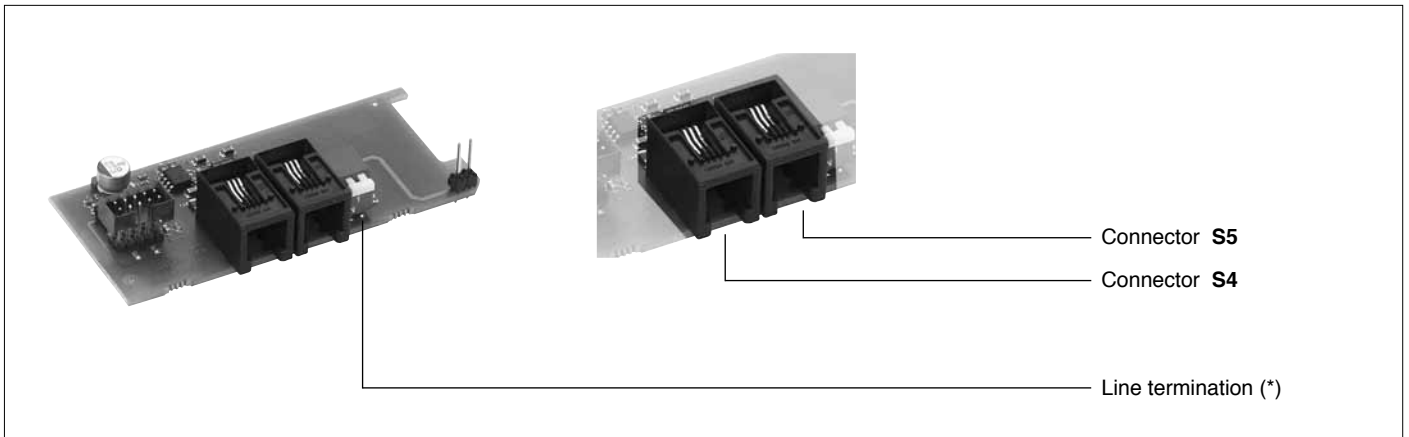
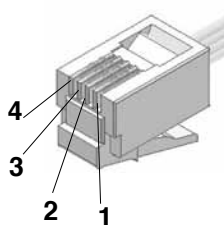

Table 19

Connector S4/S5 RJ10 4-4	Nr. Pin	Nome	Description	Note
	1	GND1 (**)	-	(*) Insert the line termination in the last device on the Modbus line.  (**) Connect the GND signal among Modbus devices with a line distance > 100 m.
	2	Tx/Rx+	Data reception/transmission (A+)	
	3	Tx/Rx-	Data reception/transmission (B-)	
	4	+V (reserved)	-	
<b>Cable type:</b> flat telephone cable for pin 4-4 conductor 28AWG				

**Port2 (fieldbus): connectors S4, S5 MODBUS RTU/Profibus DP**

Figure 24 Port2: Fieldbus Modbus RTU/Profibus DP Interface

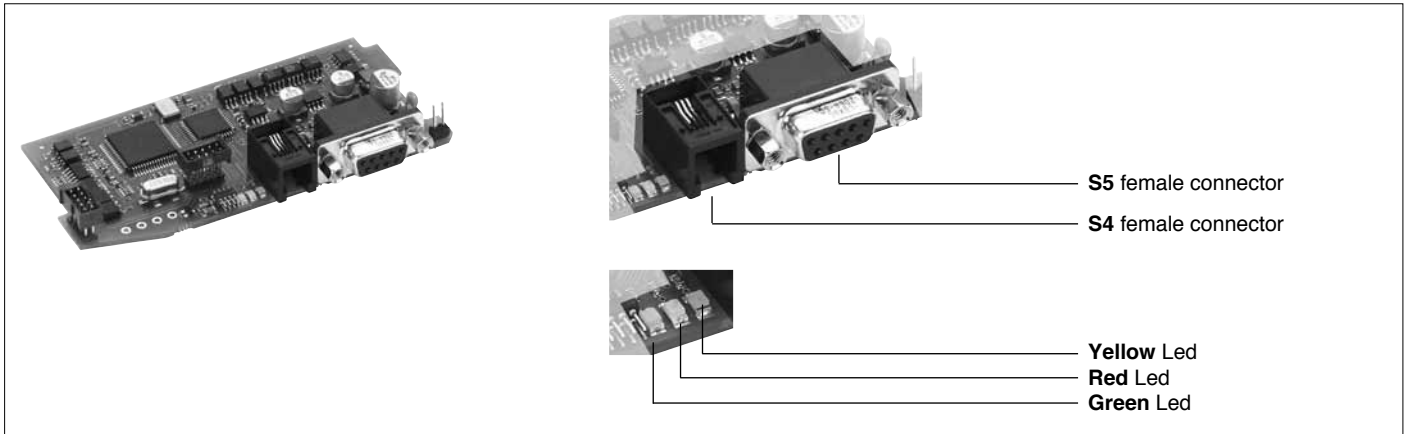
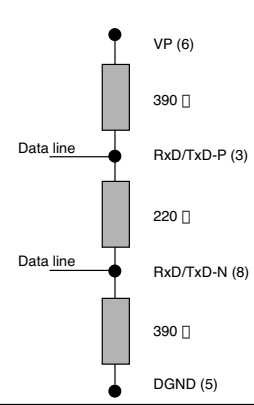

Table 20

Connector S4 RJ10 4-4	Nr. Pin	Nome	Description	Note
	1	GND1 (**)	-	(**) Connect the GND signal among Modbus devices with a line distance > 100 m.
	2	Rx/Tx+	Data reception/transmission (A+)	
	3	Rx/Tx-	Data reception/transmission (B-)	
	4	+V (riservato)	-	
<b>Cable type:</b> flat telephone cable for fin 4-4 conductor 28AWG				

Table 21

Connector S5 D-SUB 9 pins male	Nr. Pin	Nome	Description	Note
	1	SHIELD	EMC protection	Connect the terminal resistances as shown in the figure.
	2	M24V	Output voltage - 24V	
	3	RxD/TxD-P	Data reception/transmission	
	4	n.c.	n.c.	
	5	DGND	Massa di Vp	
	6	VP	Positive power supply +5V	
	7	P24V	Output voltage +24V	
	8	RxD/TxD-N	Data reception/transmission	
	9	n.c.	n.c.	
<b>Cable type:</b> Shielded 1 pair 22AWG conforming to PROFIBUS.				



**Port2 (fieldbus): connectors S4, S5 MODBUS RTU/CANopen**

Figure 25 Port2: Fieldbus Modbus RTU/CANOpen Interface

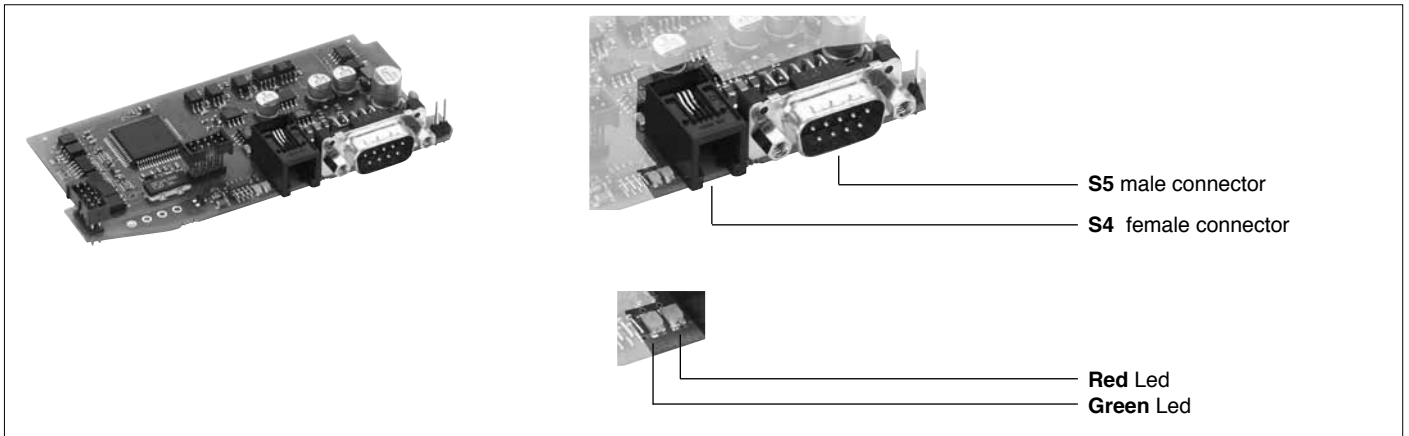
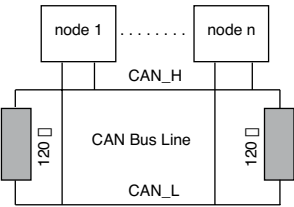

Table 22

Connector S4 RJ10 4-4	Nr. Pin	Nome	Description	Note
	1	GND1 (**)	-	(**) Connect the GND signal among Modbus devices with a line distance > 100 m.
	2	Rx/Tx+	Data reception/transmission (A+)	
	3	Rx/Tx-	Data reception/transmission (B-)	
	4	+V (riservato)	-	
<b>Cable type:</b> flat telephone cable for fin 4-4 conductor 28AWG				

Table 23

Connector S5 D-SUB 9 pins female	Nr. Pin	Nome	Description	Note
	1	-	Reserved	Connect the terminal resistances as shown in the figure.
	2	CAN_L	CAN_L bus line (domination low)	
	3	CAN_GND	CAN Ground	
	4	-	Reserved	
	5	(CAN_SHLD)	Optional CAN Shield	
	6	(GND)	Optional Ground	
	7	CAN_H	CAN_H bus line (domination high)	
	8	-	Reserved	
	9	(CAN_V+)	Optional CAN external positive supply (dedicated for supply of transceiver and optocouplers, if galvanic isolation of the bus node applies)	
<b>Cable type:</b> Shielded 2 pairs 22/24AWG conforming to CANopen.				



**Port2 (fieldbus): connectors S4, S5 MODBUS RTU/DeviceNet**

Figure 26 Port2: Fieldbus Modbus RTU/DeviceNet Interface

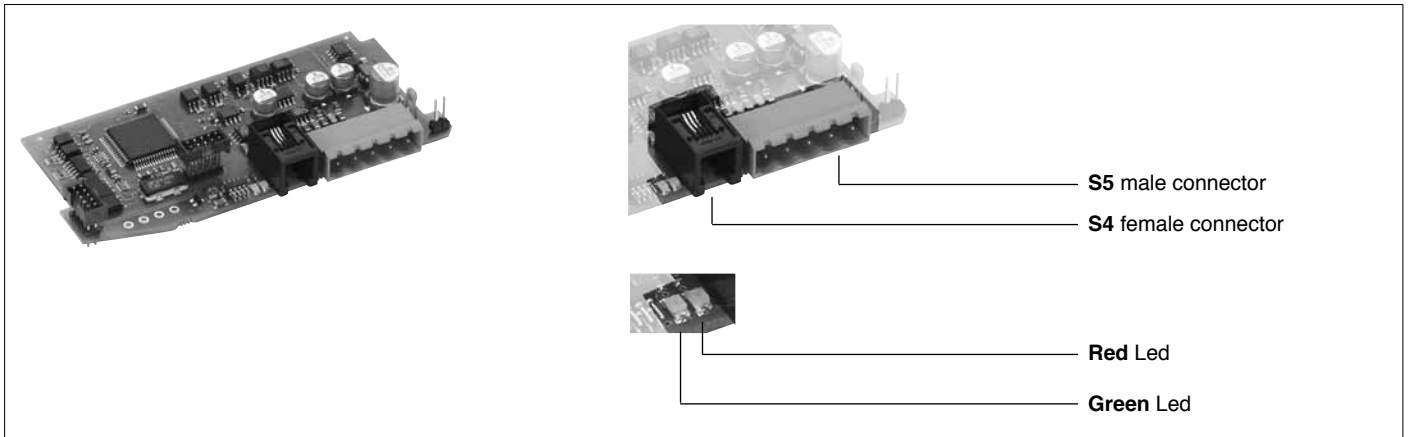

Table 24

Connector S4 RJ10 4-4	Nr. Pin	Nome	Description	Note
	1	GND1 (**)	-	(**) Connect the GND signal among Modbus devices with a line distance > 100 m.
	2	Rx/Tx+	Data reception/transmission (B)	
	3	Rx/Tx-	Data reception/transmission (A)	
	4	+V (riservato)	-	
<b>Cable type:</b> flat telephone cable for fin 4-4 conductor 28AWG				

Table 25

Connector S5 MC-1,5/5 - ST1-5,08 5 pins female	Nr. Pin	Nome	Description	Note
	1	V-	Negative power supply	Connect a 120Ω / 1/4W resistance between the "CAN_L" and "CAN_H" signals at each end of the DeviceNet network.
	2	CAN_L	Low signal	
	3	SHIELD	Shield	
	4	CAN_H	high signal	
	5	V+	Positive power supply	
<b>Cable type:</b> Shielded 2 pairs 22/24AWG conforming to DeviceNet.				

**Port2 (fieldbus): connectors S4, S5 Modbus RTU/ Ethernet Modbus TCP**

Figure 27 Port2: Modbus RTU / Ethernet Modbus TCP interface

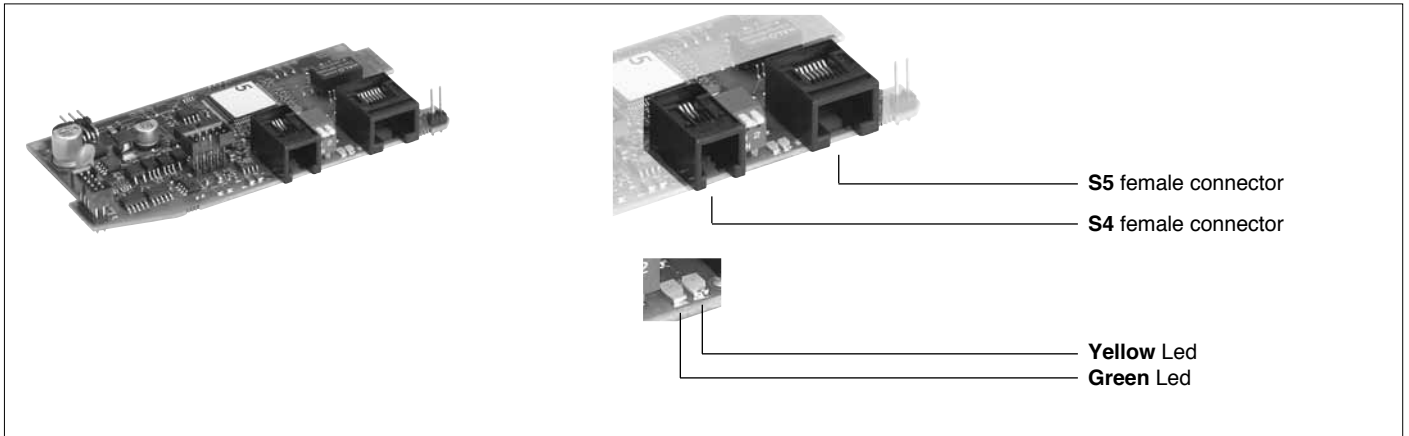

Table 26

Connector S4 RJ10 4-4	Nr. Pin	Nome	Description	Note
	1	GND1 (**)	-	(**) Connect the GND signal among Modbus devices with a line distance > 100 m.
	2	Rx/Tx+	Data reception/transmission (A+)	
	3	Rx/Tx-	Data reception/transmission (B-)	
	4	+V (riservato)	-	
<b>Cable type:</b> flat telephone cable for pin 4-4 conductor 28AWG				

Table 27

Connector S5 RJ45	Nr. Pin	Nome	Description	Note
	1	TX+	Data transmission +	
	2	TX-	Data transmission -	
	3	RX+	Data reception +	
	4	n.c.		
	5	n.c.		
	6	RX-	Data reception -	
	7	n.c.		
	8	n.c.		
<b>Cable type:</b> Use standard category 6 cable according to TIA/EIA-568A				

**Port2 (fieldbus): connectors S4, S5 Modbus RTU/ Ethernet IP or Modbus RTU / EtherCAT or Modbus RTU / ProfiNET**

Figure 28 Port2: Modbus RTU / Ethernet IP or Modbus RTU/EtherCAT or Modbus RTU / ProfiNET Interfaces

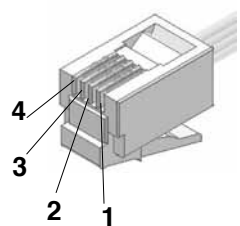
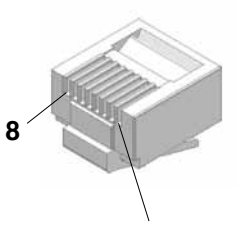

H4 and H6 LEDs are visible on the front side

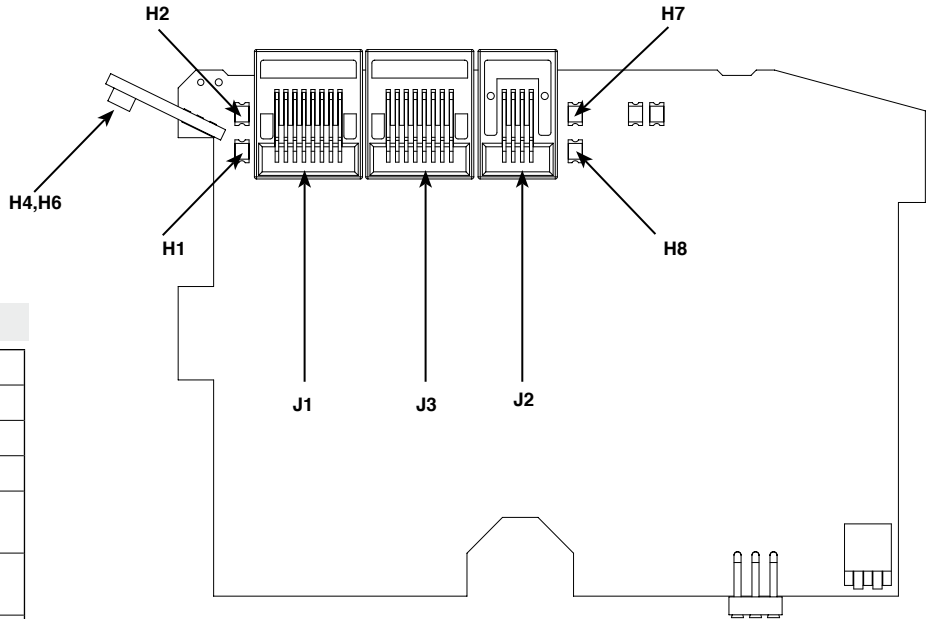
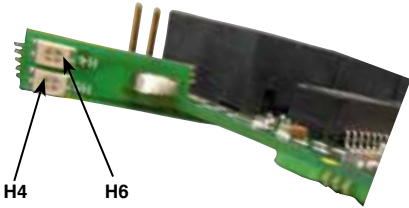

**LED Ethernet IP**

H1	Led GREEN module state	
H2	Led RED module state	
H7	Led RED network state	
H8	Led GREEN network state	
H4	Led bicolor GREEN (H1) RED (H2)	
H6	Led bicolor GREEN (H8) RED (H7)	
J1	Connector	Port ETH0
J3	Connector	Port ETH1
J2	Connector	Serial Modbus

**LED EtherCAT**

H1	Led GREEN link/activity	Port ETH0
H2	Led RED run	Run
H7	Led RED run	Run
H8	Led GREEN link/activity	Port ETH1
H4	Led bicolor GREEN (H1) RED (H2)	Port ETH0
H6	Led bicolor GREEN (H8) RED (H7)	Port ETH1
J1	Connector	Port ETH0 (IN)
J3	Connector	Port ETH1 (OUT)
J2	Connector	Serial Modbus

**LED ProfiNET**

H1	Led GREEN LINK	Port ETH0
H2	Led RED signal	Port ETH0
H7	Led RED activity	Port ETH1
H8	Led GREEN LINK	Port ETH1
H4	Led bicolor GREEN (H1) RED (H2)	Port ETH
H6	Led bicolor GREEN (H8) RED (H7)	Port ETH
J1	Connector	Port ETH0
J3	Connector	Port ETH1
J2	Connector	Serial Modbus

**Connector J2 RJ10 4-4 pin**

	N°Pin	Name	Description	Note
	1	GND1 (**)	-	(**) It is advisable to also connect the GND signal between Modbus devices with a line distance > 100 m
	2	Rx/Tx+	Data reception/ transmission (A)	
	3	Rx/Tx-	Data reception/ transmission (B)	
	4	+V (reserved)	-	

Cable type: flat telephonic for 4-4 pin 28AWG conductor

**Connector J1 and J3 RJ45**

	N°Pin	Name	Description	Note
	1	TX+	Data transmission +	
	2	TX-	Data transmission -	
	3	RX+	Data reception +	
	4	n.c.		
	5	n.c.		
	6	RX-	Data reception -	
	7	n.c.		
	8	n.c.		

Cable type: use standard category 5 cable according to TIA/EIA-568B

### 3.7 CONNECTION EXAMPLE: COMMUNICATION PORTS

Integration of GFXTERMO4 with GEFLEX modules connected in RS485 Modbus

Figure 29

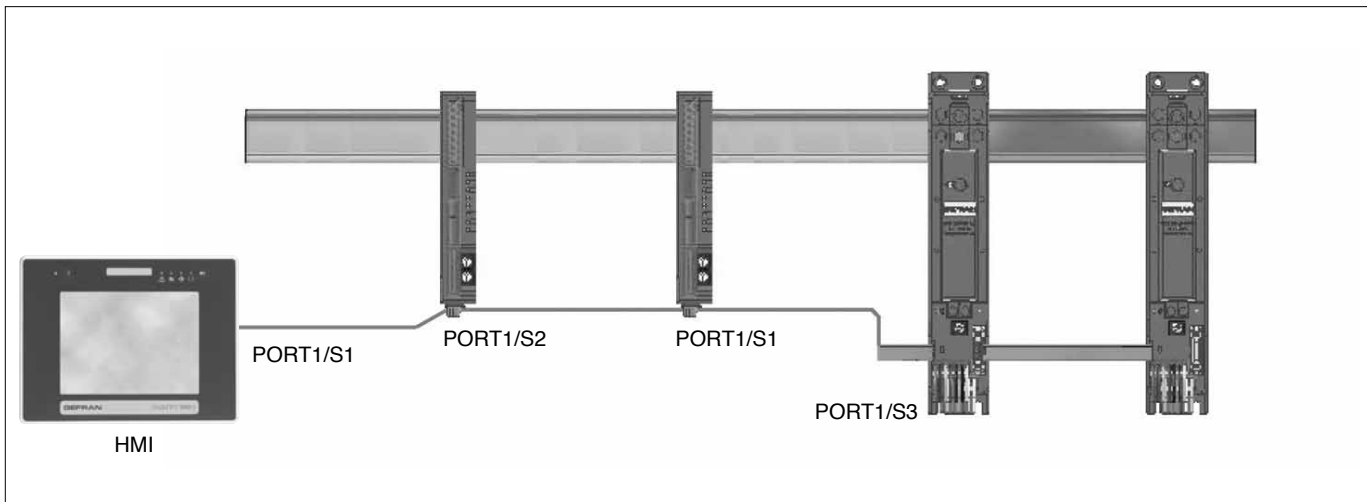

Figure 30

Supervision from PC/PLC simultaneous with GFXOP configuration terminal (each module must have a fieldbus interface)

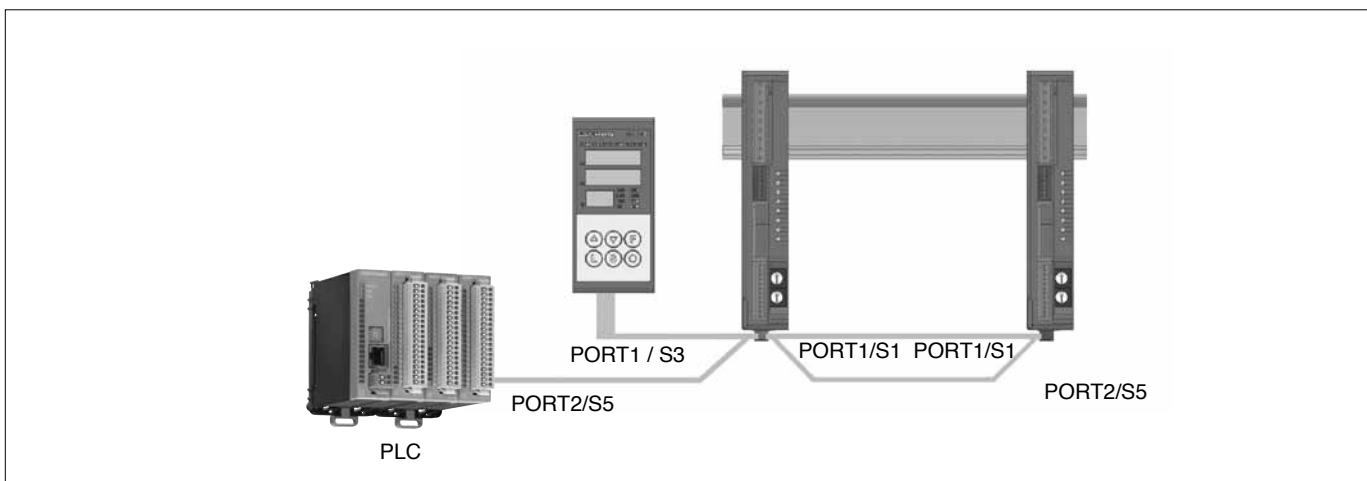
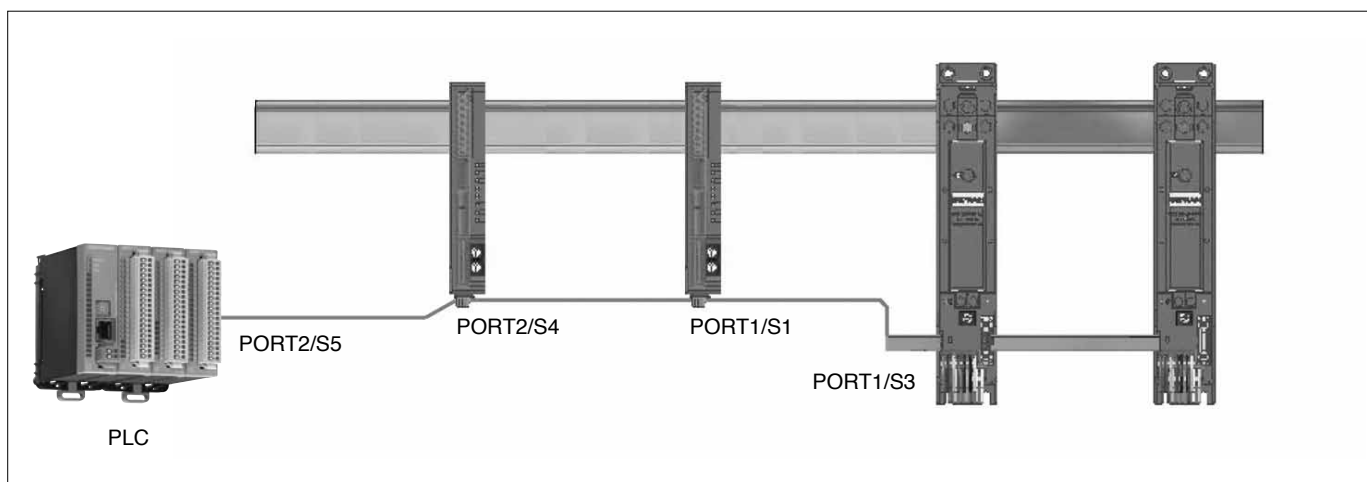

Figure 31

Supervision from PC/PLC via a single module equipped with fieldbus interface



## 4 • INSTALLATION OF “MODBUS” SERIAL NETWORK

A network typically has a Master that “manages” communication by means of “commands,” and Slaves that carry out these commands.

GFXTERMO4 modules are considered Slaves to the network master, which is usually a supervision terminal or a PLC.

They are positively identified by means of a node address (ID) set on rotary switches (tens + units).

A maximum of 99 GFXTERMO4 modules can be installed in a serial network, with node address selectable from “01” to “99” in standard mode or can also create a network with GFXTERMO4 and Geflex mixed in Geflex compatible mode, in which each GFX4 identifies 4 zones with sequential node address starting with the code set on the rotary switches.

GFXTERMO4 modules have a ModBus serial (Serial 1) and, optionally (see order code) a Fieldbus serial (Serial 2) with one of the following protocols: Modbus RTU, Profibus DP, CANOpen, DeviceNet e Ethernet Modbus TCP.

The MODBUS RTU port 1 has the following factory settings (default):

Parameter	Default	Range
ID	1	1...99
BaudRate	19,2Kbit/s	1,2...57,6 kbit/skbit/s
Parity	None	parity/odd parity/none
StopBits	1	-
DataBits	8	-

The following procedures are indispensable for the Modbus protocol. For the other protocols, see the specific Geflex manuals.

The use of rotary switches (A...F) letters is for particular procedures described in the following paragraphs.

Here are the tables showing them:

Procedure	Positions of rotary switches		Description
	Tens	Units	
AutoBaud	0	0	It enables to set the correct BaudRate value
*AutoNode	A	0	It enables to transfer the correct node (ID) address (tens) to eventual GFX4/GFXTERMO4 S1/S2



\* **Note:** the AutoNode procedure is also required for Profibus DP, CANOpen, DeviceNet, Ethernet Modbus/TCP protocols. Check its correct address in the specific manuals in question



## 4.1 “AUTOBAUD SERIAL 1” sequence

### Function

Adapt the serial communication speed and parity of the GFXTERMO4 modules to the connected supervision terminal or PLC.



Green LED L1 “STATUS” mentioned in the procedure can vary its behavior based on parameter Ld.1, which is set to a default value of 16.

### Procedure

- 1) Connect the serial cables for all modules on the network to serial 1 and to the supervision terminal.
- 2) Set the rotary switch on the GFXTERMO4 modules to be installed, or on all modules present in case of first installation, to position “0+0”.
- 3) Check that the green “STATUS” LEDs flash at high frequency (10Hz).
- 4) The supervision terminal must transmit a series of generic “MODBUS” read messages to the network.
- 5) The procedure is over when all of the green L1 “STATUS” LEDs on the Geflex modules flash at a normal frequency (2Hz) (if parameter 197 Ld.1 = 16 as default).

The new speed parameter is saved permanently in each GFXTERMO4; therefore, the “AUTOBAUD SERIAL 1” sequence does not have to be run at subsequent power-ups.



When the rotary switch is turned, the green “STATUS” LED stays on steadily for about 6 seconds, after which it resumes normal operation and saves the address.

## 4.2 “AUTONODE PORT 1” sequence

### Function

Assigning the GFX4/GFXTERMO4 node (ID) address ten to GEFLEX S1/S2.



The L1 “STATUS” green led mentioned in the procedure can vary its behaviour according to the Ld.1 parameter which is 16 as default.

### Procedure

- 1) Connect the serial cables to all the module in the serial 1 network, disconnect supervision or GFX-OP terminals.
- 2) Turn the rotary switches from the set node address to the position “A+0”.
- 3) Check that the “STATUS” green led is blinking at an average frequency (5Hz) for 10 seconds and then that it returns to normal blinking (2Hz).
- 4) Turn the rotary switches in the position of the node address.

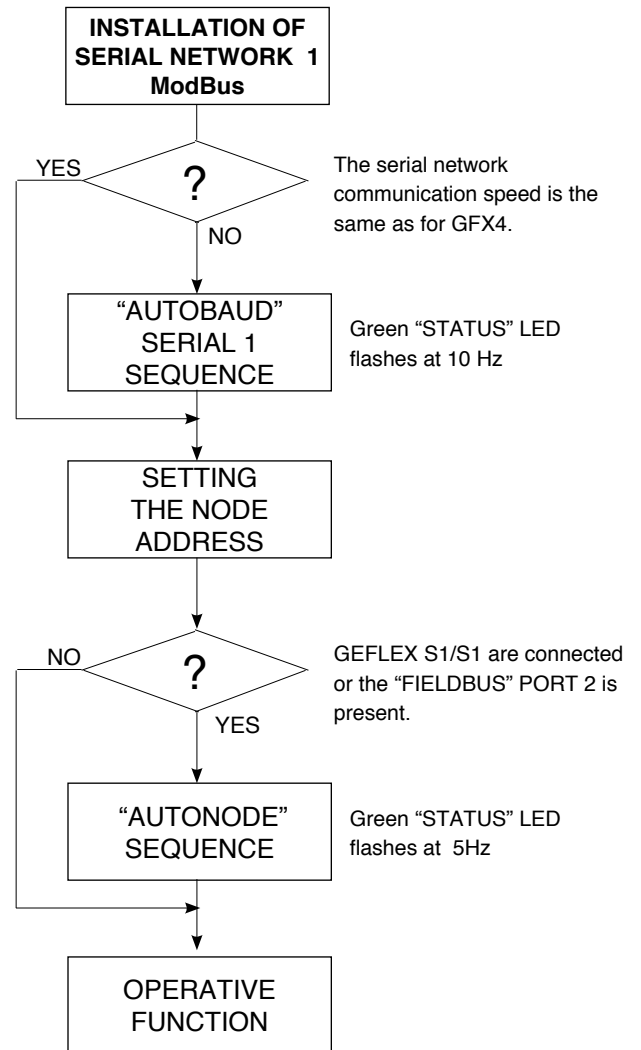

## 5 • TECHNICAL DATA

INPUTS	
<b>IN1,...,IN4 analog process inputs</b>	
Function	Acquisition of process variable
Max error	0,2% f.s. $\pm$ 1 scale point at room temperature of 25°C
Thermal drift	< 100 ppm/°C f.s.
Sampling time	120 ms
Thermocouple Tc (ITS90)	J,K,R,S,T (IEC 584-1,CEI EN 60584-1, 60584-2) Fault cold junction comp 0,1°C
Resistance thermometer RTD (ITS90)	Pt100 (DIN 43760) MMax line resistance 20ohm
Voltage	linear: 0,...,60mV, Ri>1Mohm 0,...,1V, Ri>1Mohm a 32 segment custom linearization can be inserted
Current	Linear: 0/4...20mA, Ri =50ohm a 32 segment custom linearization can be inserted
<b>IN5,...,IN8 auxiliary analog inputs (option) (in alternative to auxiliary analog inputs IN9...IN12)</b>	
Function	Acquisition of variables
Accuracy	1% f.s. $\pm$ 1 scale point at room temperature of 25°C
Sampling time	480 ms
Thermocouple Tc (ITS90)	J,K,R,S,T (IEC 584-1,CEI EN 60584-1, 60584-2) Fault cold junction comp 0,1°C
Voltage	linear: 0,...,60mV, Ri>1Mohm
<b>IN9,...,IN12 inputs internal current transformers CT (in alternative to auxiliary analog inputs IN5...IN8)</b>	
Function	Read internal CTs
Accuracy	1% f.s. $\pm$ 1 scale point at room temperature of 25°C
Sampling time	60 ms
External CT	50mAac; 50/60Hz (Ri=10Ω)
<b>DI1,...,DI2 digital inputs</b>	
Function	Configurable (default: disabled)
Type	PNP, 24Vdc, 8mA 3500V isolation
OUTPUTS	
<b>OUT1,...,OUT4 heat control outputs</b>	
	Function Configurable (default: heat control) Control state is displayed by LED (O1,...,O2)
<b>OUT5,...,OUT8 cool control outputs (option)</b>	
Function	Configurable (default: cool control)
Relay type	3A NO contact, 250V/30Vdc cosφ =1
Continuous type	0/2...10V, max 25mA protection against short circuit 0/4...20mA, max. load 500ohm 1500V isolation
Logic type	24Vdc, > 18V a 20mA
Triac type	230V/ max 4A AC51 (1A for four)
<b>OUT9, OUT10 alarms</b>	
Function	Configurable (default: alarms)
Relay type	5A NO contact, 250V/30Vdc cosφ =1

COMMUNICATION PORTS	
<b>PORT1</b>	
Function	Local serial communication
Protocol	ModBus RTU
Baudrate	Settable to 1,2,...,57,6 Kbit/s, (default 19,2Kbit/s)
Address node	Settable by rotary switch
Type	RS485 1500V isolation, double connector RJ10 telephone type 4-4
<b>PORT2 (Fieldbus option)</b>	
Function	Fieldbus serial communication
Protocol	ModBus RTU, tipo RS485, baudrate 1,2,...,57,6 Kbit/s CANOpen 10K...1Mbit/s DeviceNet 125K...0,5Mbit/s Profibus DP 9,6K...12 Mbit/s Ethernet Modbus TCP, Ethernet IP 10/100Mbps EtherCAT, ProfiNET 100Mbps
FUNCTIONS	
Safety	Detects short circuit or open probe circuit, probe , power supply failure, LBA alarm, HB alarm
Selection °C/°F	Configurable
Linear scale range	-1999...9999
Control actions	4 control loops: Double action (heat/cool) Pid, on-off Self-tuning at power-up, Continuous Autotuning, One-shot Autotuning
pb-dt-it	0,0...999,9 % – 0,00...99,99 min – 0,00...99,99 min
Action – control outputs	heat/cool – ON/OFF, PWM, GTT
Heat/cool max. power limitation	0,0...100,0 %
Cycle time - Softstart	0...200 s - 0,0...500,0 min
Impostazione potenza di fault	-100,0...100,0 %
Fault power setting	-100,0...100,0 %
Shut-down function	Maintains sampling of process variable PV; when active, disables control
Configurable alarms	Alarm is assigned to an output, configurable as: maximum, minimum, symmetrical, absolute/deviation, LBA, HB
Alarm masking	Exclusion at power-up, latch, reset by digital input
Diagnostics	Load interrupted or no voltage (no current, no voltage on SCR with control ON)
Connection and load types	4 loads single-phase,
Selection with dip-switches	2 loads 3-phase, star without neutral controlled on two phases 2 loads 3-phase, closed triangle controlled on two phases 1 load 3-phase, star with neutral controlled on one phase 1 load 3-phase, open triangle controlled on one phase (with 3-phase load, 4 CTs are needed if diagnostics is required)
GENERAL DATA	
Power supply	24Vdc ±25%, max 9VA Class II - Unit shall be supplied by SELV unit
Indicators	Eight LEDs: RN CPU in run state ER fault signal DI1, DI2 state of digital inputs O1,...,O4 state of outputs
Protection	IP20
Work/storage temperature	0...50°C/-20...70°C
Relative Humidity	20...85% Ur non-condensing
Ambient work conditions	indoor use, altitude up to 2000m
Mounting	DIN rail EN50022 or panel mount by screws
Installation instructions	Instllation category II, pollution level 2, double isolation A suitable Electrical, Fire and Mechanical enclosure shall be provided in the final application
Weight	320g.

## 6 · COMMERCIAL INFORMATION



This section contains information on order codes for the Controller and its main accessories

immediately identifies the unit's hardware configuration. Therefore, you must always give the order code when contacting Gefran Customer Care for the solution to any problems.

As mentioned in the Preliminary Instructions in this User Manual, a correct reading of the Controller order code

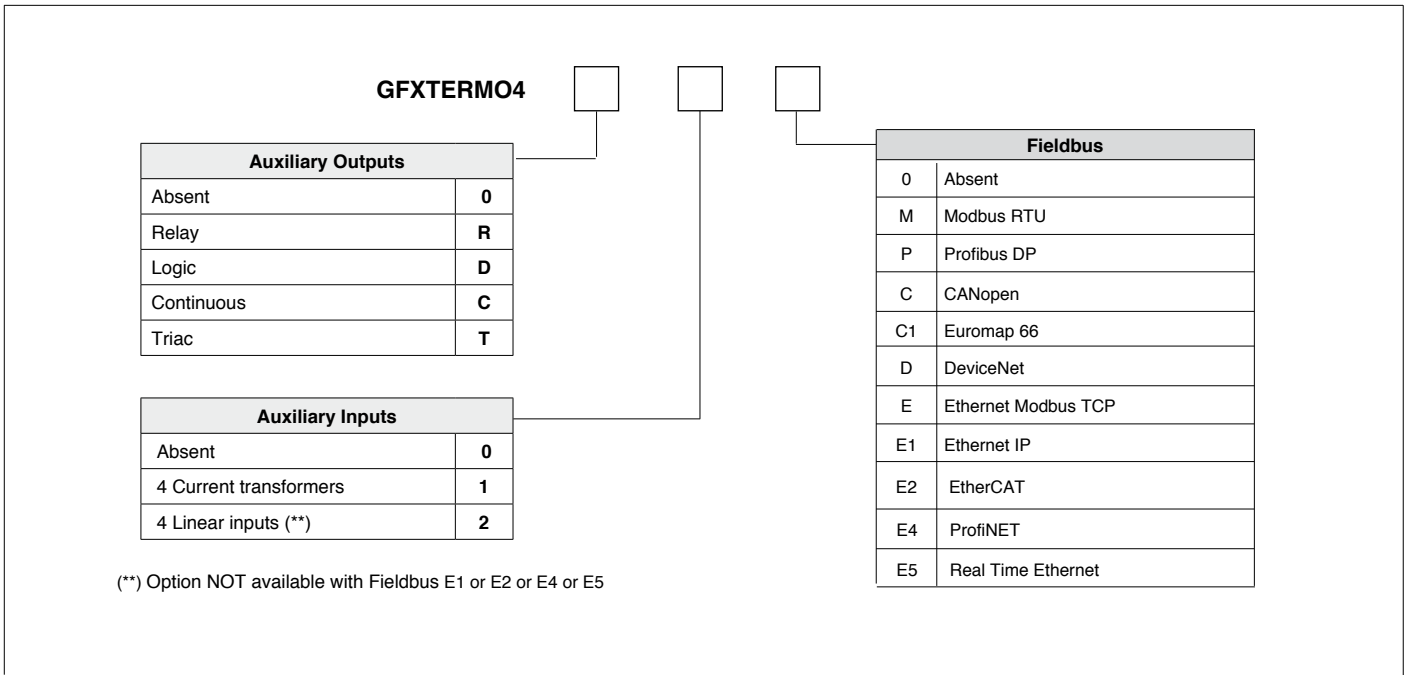

GEFRAN spa reserves the right to make any aesthetic or functional changes at any time and without notice.

### 6.1 ACCESSORIES

#### · KIT for GEFTRAN instrument configuration



kit for PC via the USB port (Windows environment) for configuration

Lets you read or write all of the parameters

A single software for all models

- Easy and rapid configuration
- Saving and management of parameter recipes
- On-line trend and saving of historical data

Component Kit:

- Connection cable PC USB <----> TTL port
- Connection cable PC USB <----> RS485 port
- Serial line converter
- CD SW GF Express installation

#### ORDERING CODE

GF\_eXK-2-0-0.....Cod. F049095

### GFX-OP



Operator terminal for in-field configuration of the entire Geflex line.

Two types of terminals:

- for installation on Geflex heatsink or on DIN guide
- for panel installation

#### ORDER CODE

Programming terminal for Geflex (installation on DIN guide or on heatsink), complete with cables for connection to Geflex (L = 0.2m) ..... **GFX-OP-D**  
 [Note: for other connection cable lengths, see the cable section in the accessories catalog]

Programming terminal for Geflex (panel installation) ..... **GFX-OP-P**  
 [Note: for connection cable, see the cable section in the accessories catalog]

Kit consists of:

power supply, PC <--> GFX-OP-D connection cable (L=2 m),

adapter for Geflex power supply..... **GFX-OP-K**